

Tantalum Hybrid[®] Capacitor Life Test

David A. Evans
Evans Capacitor Company
33 Eastern Avenue
East Providence, RI 02914
401-435-3555
devans@evanscap.com

Abstract

Tantalum Hybrid capacitors have been selected for use in military laser power supplies and airborne radar systems. These applications require very high specific power, high energy density, and high reliability. A common question is, how long will this capacitor last in a given application. The question of reliability can be answered by observing changes to electrical properties occurring over time in capacitors operating under conditions of voltage and temperature existing in the intended use. A failure can be defined as a change in ESR or capacitance which exceeds some predetermined limit, such as the specified tolerance range. Because these changes happen very slowly under normal conditions, it can take years before a sufficient number of failures has been accumulated to draw any conclusion about reliability. In order to decrease the time period, normal ageing is accelerated by making the operating conditions more severe.

This work focuses on optimization and life testing of THQA2016502, a hermetic tantalum Hybrid capacitor with a 5mF, 16 volt rating. Ageing was accelerated by exposing the capacitors to voltage above the rated voltage in an 85°C environment. The original capacitor was modified based on test results, leading to a more optimal, more reliable design. The test also yielded valuable general information concerning Hybrid capacitor engineering. Capacitance and ESR data over 5,040 hours of testing are presented.

Introduction

The tantalum Hybrid capacitor (Patent No. 5,369,547) is a series combination of a dielectric oxide film capacitance, Ta₂O₅, and a high electrochemical capacitance, a film of the conductive metal oxide, RuO₂. The result is a polar capacitor; with the Ta₂O₅ film, the positive and the RuO₂ film the negative electrodes. A high potential can be maintained across the thin electrochemically formed Ta₂O₅ film, while the RuO₂ film remains at low potential. This allows high cell voltage without fear of reaching the electrolyte breakdown potential.

The advantages of the Hybrid capacitor can be considered with an understanding of common electrolytic capacitors. These devices employ thin oxide films on the both electrodes, but they are usually asymmetric, using a material of higher surface area at the negative electrode. The film on the positive electrode is thicker than the negative electrode film, and sets the working voltage of the capacitor. The negative electrode has a higher capacitance, but the two electrodes often have similar physical sizes. [1]

Presented to the 12th International Seminar on Double Layer Capacitors and Similar Energy Storage Devices, December 9-11, 2002, Deerfield Beach, Florida.

The overall capacitance, C , can be determined by analysis of the equivalent series circuit for an electrolytic capacitor, shown in Figure 1. For series capacitors,

$$1/C = 1/C_a + 1/C_c, \quad (1)$$

where C_a and C_c respectively are the positive and negative electrode capacitances.

In the Hybrid capacitor, since $C_c \gg C_a$, the overall capacitance is determined by C_a . Because the RuO_2 negative electrode requires little volume, available space can be used to enlarge the positive electrode. The result is a capacitor with at least four times the energy density of a tantalum electrolytic capacitor.

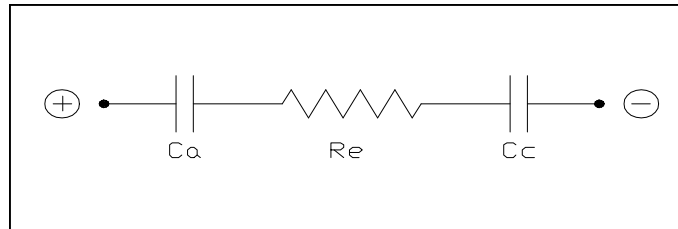

Figure 1. Electrical schematic of an electrolytic capacitor. The individual positive and negative electrode capacitances are connected in series by the electrolyte.

The tantalum Hybrid capacitor positive electrode is a pressed, sintered pellet of high capacitance density tantalum powder. Formation of the Ta_2O_5 film is done electrochemically in aqueous electrolyte until a thickness corresponding to a certain voltage is reached. This determines the working voltage of the capacitor, which is in the range of 3 to 175 volts for devices produced by Evans Capacitor.

The negative electrode is a high capacitance density film of RuO_2 bonded to a thin tantalum foil. The bulk capacitance of the RuO_2 electrode material is approximately 50F/g. The capacitance density of the RuO_2 film is approximately 50mF/cm². Therefore, only a small amount of RuO_2 is required.

Hybrid capacitors are capable of high working voltages without resorting to series connected cells. Low cell voltage, limited to the electrolyte breakdown potential (ca. 1.2 volts, aqueous, 3.5 volts, nonaqueous) is a consideration of practical importance in applying symmetric electrochemical capacitors because most situations will require higher voltages calling for multiple series connection of units. Since the voltage on a series of cells will not divide evenly, due to differences in cell characteristics arising during manufacture, the operating voltage must be reduced, so that electrolyte breakdown does not occur in any cell. There are performance penalties, as stacking units in series not only lowers the capacitance according to the rule stated above, but also increases the ESR in direct proportion to the number of cells

Although the capacitance values of Hybrid capacitors are orders of magnitude lower compared to symmetric electrochemical capacitors of similar physical size, the Hybrid capacitor can have a similar energy density. The reason for this is the total energy stored by a capacitor is proportional to the capacitance times the square of the cell voltage. Therefore, a 100μF, 100V capacitor stores the same energy as a 1F, 1V capacitor. Because the need for series cell stacking is eliminated, Hybrid capacitors have the advantage of substantially lowered ESR and consequently better frequency response. As an additional economic advantage, much less RuO_2 is required per joule of energy stored in the Hybrid capacitor compared to the symmetric RuO_2 device.

The cell potential, as stated previously, is divided unevenly in a Hybrid capacitor. Because the electrodes are in series, the charge (Q) accumulated at the negative electrode must

equal the charge lost at the positive electrode. Since $Q=C \cdot V$, the following relationship exists

$$V_a \cdot C_a = Q = V_c \cdot C_c$$

Rearranging these terms it follows that,

$$V_c = V_a \cdot C_a / C_c$$

For a Hybrid capacitor $C_c \gg C_a$, so $V_a \gg V_c$. By design, in order to prevent the electrolyte reduction potential from being exceeded at the negative electrode, the negative electrode capacitance (C_c) must have a minimum value. A safety margin is added to this capacitance. Typical tantalum Hybrid capacitor potential drop associated with the negative electrode is designed to be 0.3 volt maximum.

The preceding charge-voltage analysis applies for d.c. or where the capacitor is charged or discharged only very slowly, but for high currents commonly encountered, the effects of resistance related voltage jump must also be considered. It has been determined that the cathode voltage jump is proportional to the ratio of the internal resistance of the cathode electrode to the total resistance of the capacitor.[2] The effect of the voltage jump on capacitor life has not yet been established.

Capacitor Construction

Figure 2 shows a cross-section view of the THQA2. Central to the capacitor cell is the positive, or anode electrode. It is comprised of high surface area tantalum powder, pressed and sintered, forming a porous pellet. Integral to the pellet is an axially inserted tantalum riser wire which electrically connects the anode to the feedthru. The dimensions of the anode pellet are 0.550"

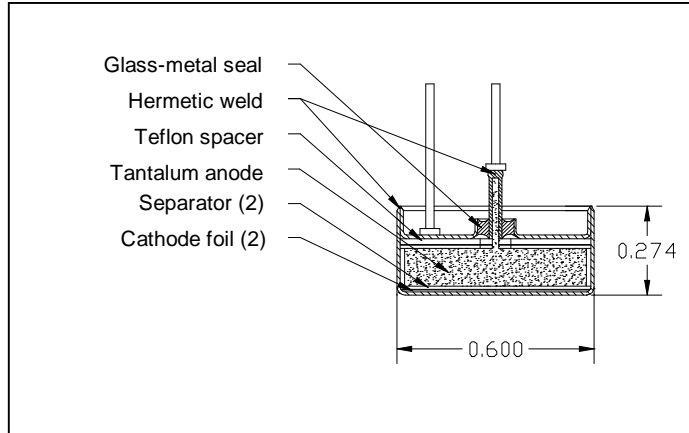

Figure 2. Cross section view of THQA2 showing major components and dimensions. The case and lid are made from tantalum. The capacitor is assembled dry, and electrolyte is admitted into the center feedthru tube by vacuum impregnation process. Final seal is secured by welding the exterior end of the tube closed.

Figure 3. Magnified image of the THQA2. To the left of the capacitor is a US 1¢ piece. The device measures 0.6" diameter X 0.274" high. The weight is 8.7 grams. The inset picture shows the capacitor held in a plastic mount, facilitating PWB assembly by the customer.



diameter and 0.125" thick. The pellet has a density of 5-8g/cm³, which is 1/2 to 2/3 the specific gravity of tantalum metal, making the pellet at least 50% open volume. The capacitor dielectric, Ta₂O₅, covers all exposed anode surfaces. The dielectric is electrochemically formed in an aqueous solution. The negative electrode or cathode is constructed of tantalum foil covered on one or both sides with a thin coating of RuO₂ active material. The capacitor has two cathodes, one facing each of the flat anode faces. The cathodes are electrically connected to the case. Between each cathode foil and the anode are porous insulating separators which inhibit electrical contact. The anode pellet is surrounded by a Teflon spacer which positions the pellet in the center of the case and prevents short-circuits. Another Teflon spacer lies between the upper cathode foil and the lid inner surface. This element transfers the compressive force on the cell to the edge, and away from the glass-metal seal. The electrical feedthru has matched coefficient of thermal expansion sealing glass over a central tantalum tube and an external stainless steel compression ring for extra mechanical support. The hermetic case and lid are of tantalum sheet, joined by TIG welding. About 350mg of 38% sulfuric acid electrolyte is added through the tube by vacuum impregnation. Finally, the tube is sealed by welding. Figure 3 is a photograph of the finished capacitor.

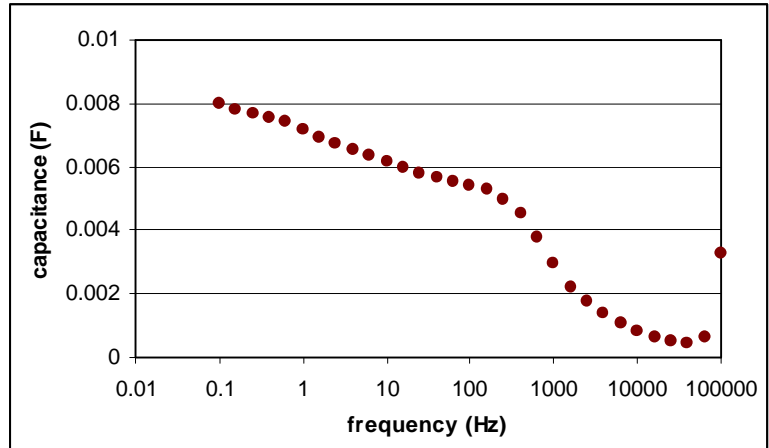

Figure 4. Capacitance vs. frequency for THQA2016502. The capacitance is 5.2mF at 120Hz.

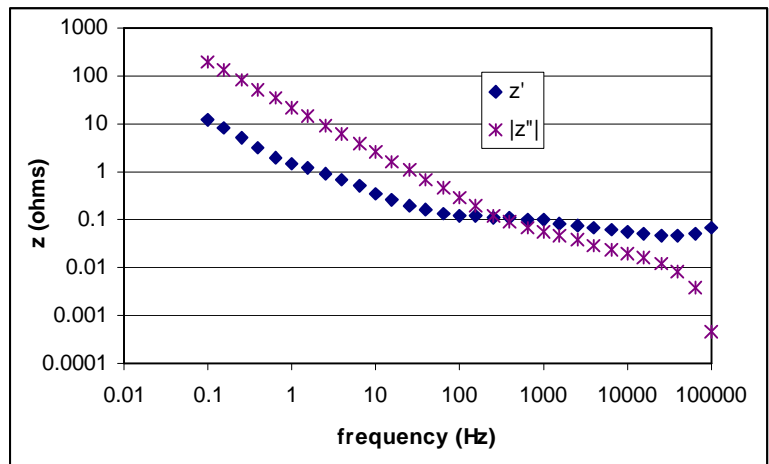

Figure 5. Impedance vs. frequency for THQA2016502. The ESR is 95mohm at 1kHz.

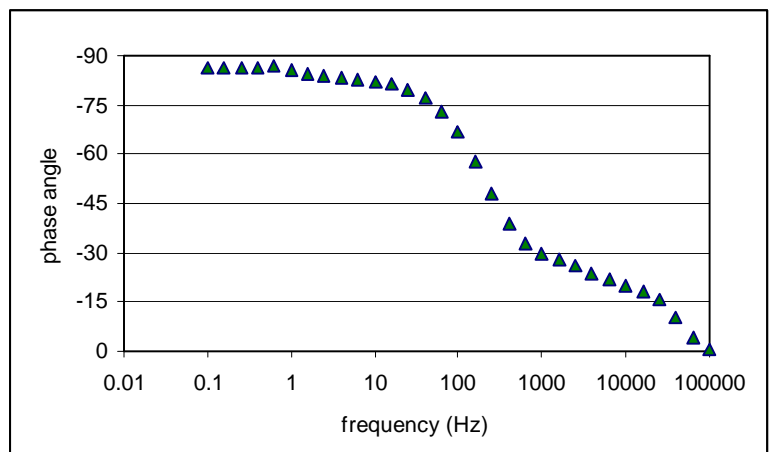

Figure 6. Phase angle vs. frequency for THQA2016502. The capacitor has a phase angle of -45° at a frequency of 275Hz. At lower frequencies, the phase angle rapidly approaches -90°.

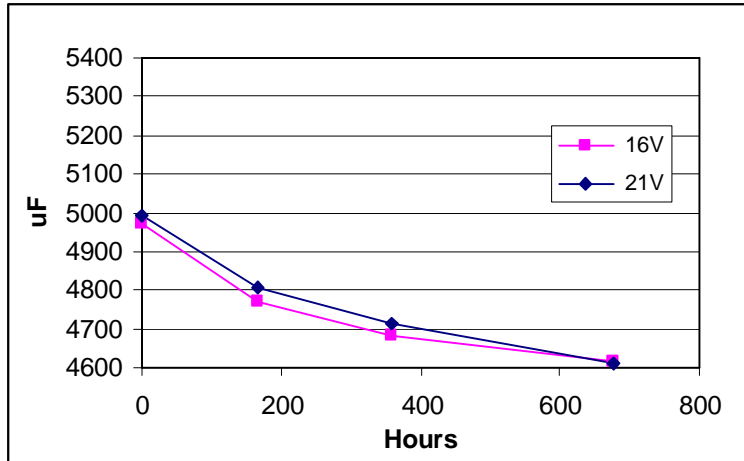

Figure 7. Capacitance (120Hz) vs. time for the initial design version of THQA2016502 shows significant capacitance loss after about 700 hours at 85°C. The capacitance loss does not appear to be related to voltage. The design capacitance is 5mF.

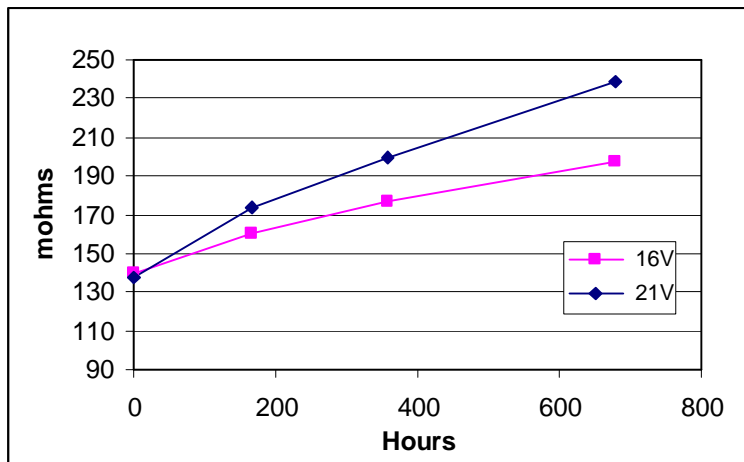

Figure 8. ESR (1kHz) vs. time for the initial design version of THQA2016502 showing substantial increase in resistance after 700 hours at 85°C. The increase is clearly dependent on voltage. The specified ESR is < 150mohm.

to observe a greater capacitance loss at 21 volts than at 16 volts. Since the rate is independent of voltage, the anode or dielectric alone were not responsible for the decreased performance. Thus by elimination, we focused our attention on the cathode.

The negative electrode contributes close to half of the total internal resistance.[2] And, it has some potential failure modes consistent with the observations. Autopsy of some of the devices with the highest resistance revealed the cathode was being attacked. The negative electrode potential must not exceed the breakdown voltage of the electrolyte. If that happens, hydrogen is produced and reacts with the tantalum foil to form a brittle, non-conductive material. The evidence of very brittle foils supports the conclusion that hydrogen embrittlement of the negative electrode was responsible for the increased resistance. In that case, one would also expect to see the 21 volt set to fare much worse than the 16 volt set.

A set of capacitors having twice the normal cathode capacitance was built and sub-

Results and Discussion

Two identical sets of twelve THQA2016502 capacitors were subjected to conditions of elevated temperature and voltage to see what effect this would have on electrical properties over time. We were hoping for at least 2,000 hours with minimal change. However, as Figures 7 and 8 show, the results of 85°C life testing revealed significant performance degradation occurring in only a few hundred hours. The rapid decline of capacitor electrical performance was an indication that physical changes have taken place in the capacitor. We needed to find the cause of the degradation before we could work on the solution.

For the reasons discussed in the previous section, the capacitance of a Hybrid capacitor is practically equivalent to the capacitance of the anode. The total change in capacitance of the device is insensitive to variation in cathode capacitance. In addition, the observed capacitance decrease was independent of operating voltage. If the dielectric layer were somehow insufficient or defective, for instance, not formed to a high enough voltage, one would expect

jected to 16 volts at 85°C. Figures 9 and 10 show the results over 5040 hours. The capacitance dropped about 5% during the first 100 hours then declined gradually about 2% more in the next 4900 hours. The ESR at the beginning of the test was 93mohm, and increased gradually to 115mohm, a change of 24% in 5040 hours. Testing continues on all devices and both ESR and capacitance remain well within the specified limits.

Based on these results, the design has been modified to call for higher cathode capacitance.

Conclusion

Life testing of THQA2016502 exposed a fault that caused a large decrease in capacitance and an increase in ESR after 700 hours exposure to 16 volts at 85°C. Autopsy revealed embrittlement of the negative electrode. The deficiency was apparently corrected by doubling the cathode capacitance. New capacitors built with 2X the cathode capacitance had a 30% lower ESR, and, subjected to the same test conditions, still meet the specified limits for capacitance and ESR after 5040 hours. The test will continue until failures have occurred. Further experimentation is planned to establish the relationship between cathode capacitance, operating voltage, and capacitor life.

References

1. B. E. Conway, "Electrochemical Supercapacitors", p. 466, Kluwer Academic / Plenum Publishers (1999).
2. T. Y. Chang et al, "Electrochemical-Electrolytic Hybrid Capacitors", p. 72-75, in Proceedings of the 40th Power Sources Conference (2002).

Hybrid[®] Capacitor is a registered trademark of Evans Capacitor Company.

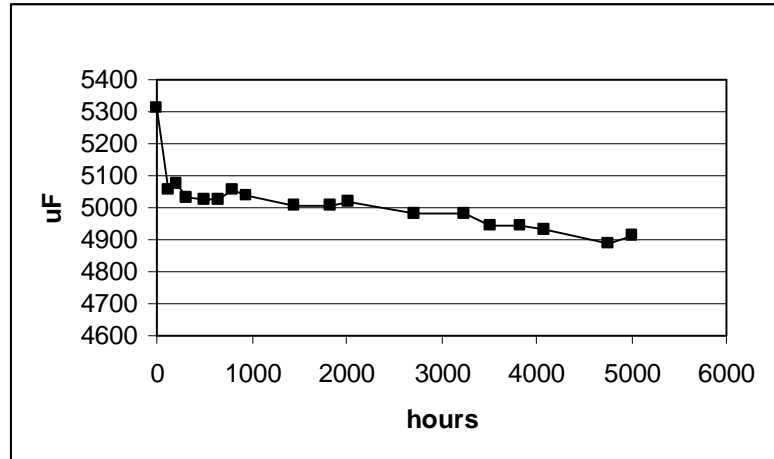

Figure 9. Capacitance (120Hz) vs. time for THQA2016502 capacitors with 2X the original cathode. The test is running at 16 volts and 85°C. After a steeper initial drop in the first 100 hours, the capacitance decreases gradually.

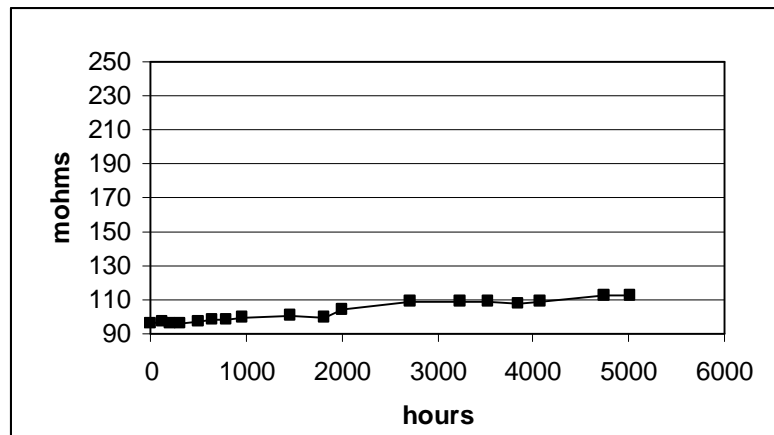

Figure 10. ESR (1kHz) vs. time for THQA2016502 capacitors with 2X the original cathode. This test is running at 16 volts and 85°C. The resistance has increased gradually since the beginning of the test.