

Tantalum Hybrid^o Capacitors for High-Power Applications

David A. Evans
Evans Capacitor Company
33 Eastern Avenue
East Providence, RI 02914
401-435-3555
snavedivad@aol.com

Abstract

Tantalum Hybrid capacitors are among the most powerful capacitors available. A new tantalum Hybrid capacitor, having a peak power density of 1.6 MW/l has been developed. The new hermetic capacitor has innovative packaging features that minimize non-active components and allow reliable assembly. The thin, flat package also tends to minimize electrical resistance while maximizing heat dissipation. This unique capacitor combines the high cell voltage capability and low resistance of an electrolytic capacitor with the increased energy density of an electrochemical capacitor.

Electrical impedance spectroscopy was used to characterize capacitor electrical properties. The new capacitor has 10X the power density of an aluminum electrolytic capacitor with similar electrical performance. The frequency response of this capacitor suits it for avionics, communications electronics, air- and surface- based radar systems, power supply, computer, and electronics applications.

Introduction

The tantalum Hybrid capacitor (Patent No. 5,369,547) is a series combination of a dielectric oxide film capacitance, Ta₂O₅, and a high electrochemical capacitance, a film of the conductive metal oxide, RuO₂. The result is a polar capacitor; with the Ta₂O₅ film, the positive and the RuO₂ film the negative electrodes. A high potential can be maintained across the thin electrochemically formed Ta₂O₅ film, while the RuO₂ film remains at low potential. This allows high cell voltage without fear of reaching the electrolyte breakdown potential.

The advantages of the Hybrid capacitor can be considered with an understanding of common electrolytic capacitors. These devices employ thin oxide films on the both electrodes, but they are usually asymmetric, using a material of higher surface area at the negative electrode. The film on the positive electrode is thicker than the negative electrode film, and sets the working voltage of the capacitor. The negative electrode has a higher capacitance, but the two electrodes often have similar physical sizes. [1]

The overall capacitance, C, can be determined by analysis of the equivalent series circuit for an electrolytic capacitor, shown in Figure 1. For series capacitors,

$$1/C = 1/C_a + 1/C_c,$$

Presented to the 11th International Seminar on Double Layer Capacitors and Similar Energy Storage Devices, December 3-5, 2001, Deerfield Beach, Florida.

where C_a and C_c respectively are the positive and negative electrode capacitances.

In the Hybrid capacitor, since $C_c \gg C_a$, the overall capacitance is determined by C_a . Because the RuO_2 negative electrode requires little volume, available space can be used to enlarge the positive electrode. The result is a capacitor with at least four times the energy density of a tantalum electrolytic capacitor.

The tantalum Hybrid capacitor positive electrode is a pressed, sintered pellet of high capacitance density tantalum powder. Formation of the Ta_2O_5 film is done electrochemically in aqueous electrolyte until a thickness corresponding to a certain voltage is reached. This determines the working voltage of the capacitor, which is in the range of 3 to 125 volts.

The negative electrode is a high capacitance density film of RuO_2 bonded to a thin tantalum foil. The bulk capacitance of the RuO_2 electrode material is approximately 50F/g. The capacitance density of the RuO_2 film is approximately 50mF/cm². Therefore, only a small amount of RuO_2 is required.

Hybrid capacitors are capable of high working voltages without resorting to series connected cells. Low cell voltage, limited to the electrolyte breakdown potential (ca. 1.2 volts, aqueous, 3.5 volts, nonaqueous) is a consideration of practical importance in applying symmetric electrochemical capacitors because most situations will require higher voltages calling for multiple series connection of units. Since the voltage on a series of cells will not divide evenly, due to differences in cell characteristics arising during manufacture, the operating voltage must be reduced, so that electrolyte breakdown does not occur in any cell. There are performance penalties, as stacking units in series not only lowers the capacitance according to the rule stated above, but also increases the ESR in direct proportion to the number of cells

Although the capacitance values of Hybrid capacitors are orders of magnitude lower compared to symmetric electrochemical capacitors of similar physical size, the Hybrid capacitor can have a similar energy density. The reason for this is the total energy stored by a capacitor is proportional to the capacitance times the square of the cell voltage. Therefore, a 100μF, 100V capacitor stores the same energy as a 1F, 1V capacitor. Because the need for series cell stacking is eliminated, Hybrid capacitors have the additional advantage of substantially lowered ESR and consequently better frequency response.

The cell potential, as stated previously, is divided unevenly in a Hybrid capacitor. Because the electrodes are in series, the charge (Q) accumulated at the negative electrode must equal the charge lost at the positive electrode. Since $Q=CV$, the following relationship exists.

$$V_a C_a = Q = V_c C_c$$

Rearranging these terms it follows that,

$$V_c = V_a C_a / C_c$$

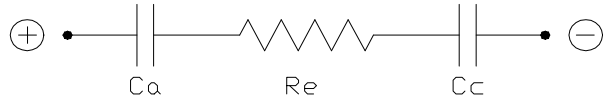

Figure 1. Electrical schematic of an electrolytic capacitor. The individual positive and negative electrode capacitances are connected in series by the electrolyte.

For a Hybrid capacitor $C_c \gg C_a$, so $V_a \gg V_c$. By design, in order to prevent the electrolyte reduction potential from being exceeded at the negative electrode, the negative electrode capacitance (C_c) must have a minimum value. A safety margin is added to this capacitance. Typical tantalum Hybrid capacitor potential drop associated with the negative electrode is designed to be 0.3 volt maximum.

Capacitor Construction

A specific purpose of this work was to develop a custom hermetic tantalum Hybrid capacitor that would maximize power density for a military application. The application required a high reliability capacitor power source rated 0.14F at 18V, with high current capability and high energy density. In order to meet the 0.005 ohm ESR requirement, the design we chose to pursue used two 2.375" X 1.690" X 0.085" tantalum anode pellets in parallel, effectively doubling the cell area. ESR was cut by a factor of two compared to a capacitor using a single pellet of twice the thickness. Each pellet weighs about 33.5g.

The case consists of a formed tantalum sheet, 0.007" thick. It had a single preformed cavities, which when folded in half, became a hollow container that held the positive electrodes, separator, and electrolyte. Tantalum is used because it resists attack by the sulfuric acid electrolyte. The case inside surfaces are coated with a film of RuO_2 . The capacitance of the film is about $60\text{mF}/\text{cm}^2$. Additional cathode material, consisting of a 0.002" tantalum foil coated on both sides with RuO_2 is placed between the anode pellets. Sheets of 0.004" thick non-woven separator prevent electrical contact between the anode pellets, the cathode foil, and the case.

To ease production, the unit is assembled dry, leaving open a small hole to serve as an electrolyte fill port. The case is sealed by laser welding along the perimeter. As the case is physically part of the cathode, isolation for the positive feedthrough is made with a glass to metal seal. Next, electrolyte (38 wt.% H_2SO_4) is added under vacuum and the final seal is made by resistance welding a plug over the fill port. Lastly, the stamped nickel terminals are attached to the case and feedthrough.



Figure 2. Photograph of the capacitor. The connections are made by soldering directly to the terminals as shown at the right center of the figure. The overall dimensions are 3.07" X 1.98" X 0.21". This device weighs 105g.

Discussion and Results

A benefit of this effort was to extend Hybrid capacitor engineering principles to the construction of larger capacitors with thin electrodes needed for high power applications, and to properly design their performance. Electrical impedance spectroscopy (EIS) was used to measure capacitor electrical characteristics. These measurements were made with a Gamry Instru-

ments CMS-100 system. Figure 3 is a plot of impedance vs. frequency. From the figure, the ESR is 0.029 ohms at a frequency of 10kHz. Figure 4 is a plot of capacitance vs. frequency. The capacitance equals 136mF at 100Hz, and is significantly higher at lower frequencies. The capacitor self-resonant frequency is about 4kHz. This point coincides with the frequency of zero phase angle and zero reactance. At higher frequencies, the effect of inductance predominates. Figure 5 is a plot of phase angle vs. frequency. An ideal capacitor has a phase angle equal to -90° . The plot shows nearly ideal behavior for frequencies below about 100Hz. The device still functions as a capacitor at a frequency of 1kHz, although a lossy one, because the phase angle has increased to about -15° at that frequency. At about 200Hz, the reactive impedance equals the resistive impedance, and the capacitor has a phase angle of -45° . This characteristic frequency is at least two orders of magnitude higher than for electrochemical capacitors with symmetric electrodes. Table 1 summarizes the important performance data for the prototype capacitor.

Although non-ideal, the Bode plots show less of the “transmission line” behavior attributed to the porous electrodes of electrochemical capacitors, and are more comparable to those of electrolytic capacitors. Table 2 compares the flatpack Hybrid capacitor electrical properties with those of a state of the art alumi-

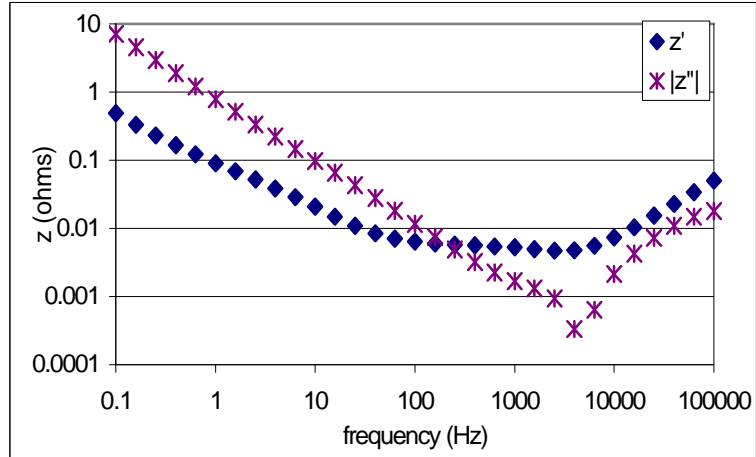

Figure 3. Resistance and reactance vs. frequency in the range of 0.1Hz to 100kHz.

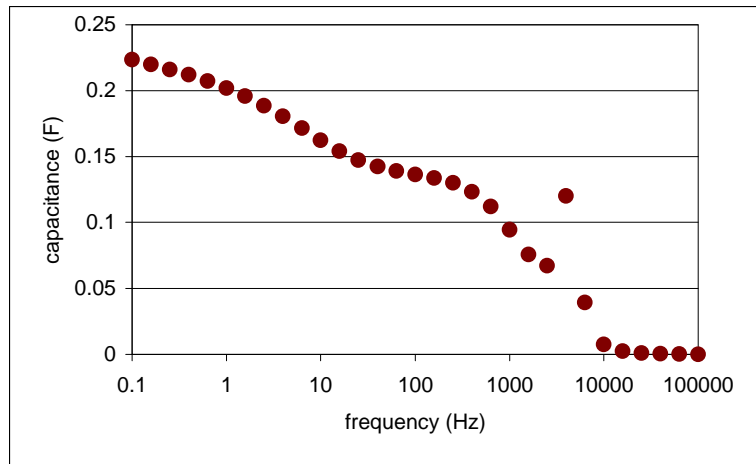

Figure 4. Capacitance vs. frequency

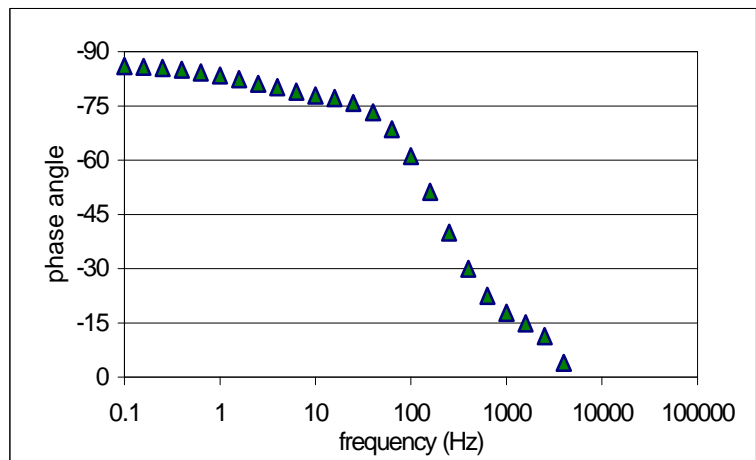

Figure 5. Phase angle vs. frequency

Table 1. Hybrid capacitor properties.

Capacitance (mF)	Working Voltage	ESR (ohms)	Leakage Current (uA)	Weight (grams)	Dimensions (inches)
136	18	0.005	100	105	3.07 X 1.98 X 0.21

num electrolytic capacitor (Nippon ChemiCon 36DA).

High Power Testing

One of the stated goals was to develop a high energy density capacitor with high power capability. To more fully understand the capacitor performance, measurements of current and voltage were made during discharge into a low resistance load.

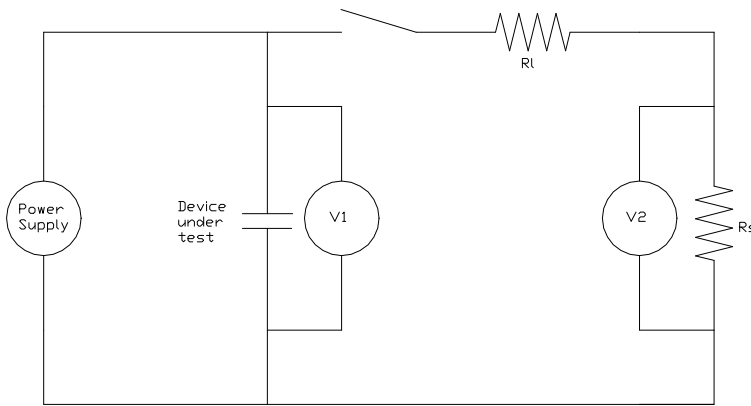

Figure 6. Test circuit diagram.

0.01 ohms. The two voltmeters, V1 and V2 were connected to the input channels of a digital oscilloscope set to trigger upon switch closure. V1 indicates the capacitor voltage plotted in Figure 7. If one neglects the effect of the power supply, the capacitor discharge current, I , is related to $V2$ by

$$I = V2/R_S.$$

I vs. time is also plotted in Figure 7. To run a test, the switch was opened and the capacitor was allowed to charge. The switch was then closed, triggering the oscilloscope. This procedure was repeated a large number of times without appreciable heating of the capacitor.

Table 2.

	Tantalum Hybrid Flatpack	Aluminum Electrolytic (Nippon Chemi-Con 36DA)
Capacitance (mF)	136	47
Voltage	18	16
Energy Density (J/cc)	1.08	0.09
Energy Density (J/g)	0.20	0.07
ESR (ohm)	.005	0.012

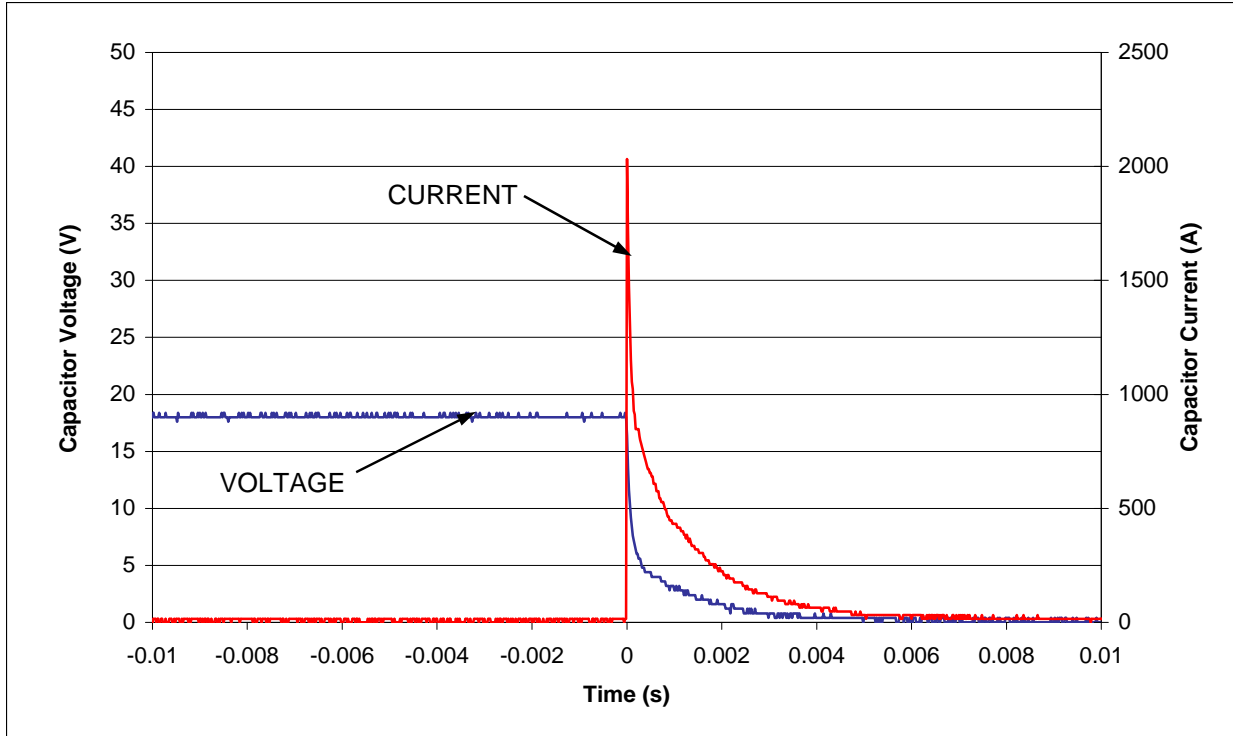
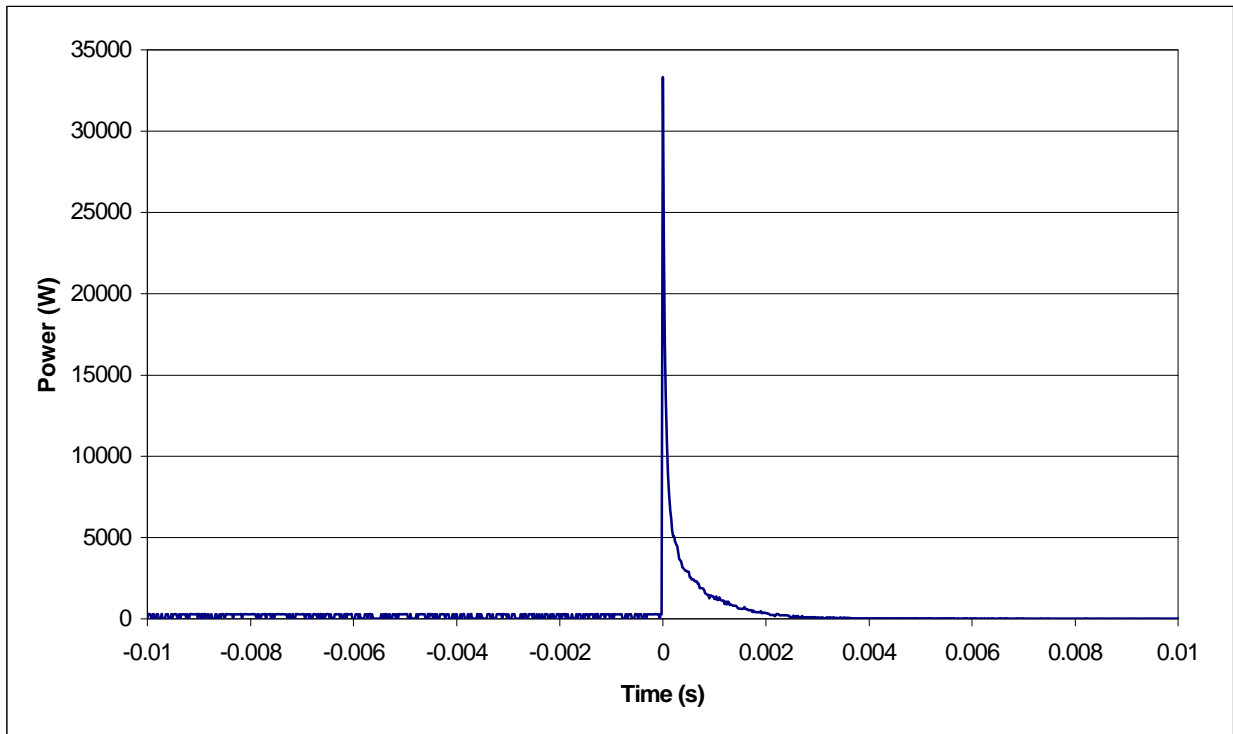

Figure 7. Current and voltage vs. time discharging the capacitor charged initially at 18V into a low-resistance load. The peak current was >2000 amps.

Figure 8. This is a plot for power vs. time for the same discharge data given in the previous figure. The power is calculated as current times voltage. A peak power of about 33kW is indicated.



Conclusion

A new tantalum Hybrid capacitor was designed and prototype units were fabricated and evaluated using EIS. The new capacitor incorporates a parallel pair of relatively thin positive electrodes, yielding an ESR of 0.005 ohms. Peak current was measured during discharge into low-resistance loads. Currents exceeding 2000A were reached. The capacitor electrical performance is similar to that of tantalum electrolytic capacitors, but the energy density for the Hybrid is at least a factor of ten higher. This suits the unit for electrolytic capacitor applications that benefit from high power density such as military, avionics, and wireless communications. Work will continue more fully characterizing the performance of these capacitors under a range of conditions in preparation to begin production.

Reference

1. B. E. Conway, "Electrochemical Supercapacitors", p. 466, Kluwer Academic / Plenum Publishers (1999).

Hybrid[®] capacitor is a registered trademark of Evans Capacitor Company.